



INSTALLATION & MAINTENANCE INSTRUCTIONS

STANDARD POWER PULLING SYSTEM



THIS MANUAL COVERS THE POWER PULLER FAMILY OF PRODUCTS:

4400
4401
4402
7662

IMPORTANT NOTES:

Keep this manual for information on use and warranty on this equipment.

For questions or problems related to this equipment, call our Customer Service Department at 1-800-451-2425. Please have your order number available when you call.

Standard Tools highly recommends that you read and understand this entire manual prior to using this equipment. Serious bodily harm and damage or equipment or property can be avoided by fully understanding this material prior to using this product.

CONTENTS

Section 1: Systems and Items of kits with photos and parts lists

Section 2: Instructions and Warnings



Section 3: Maintenance







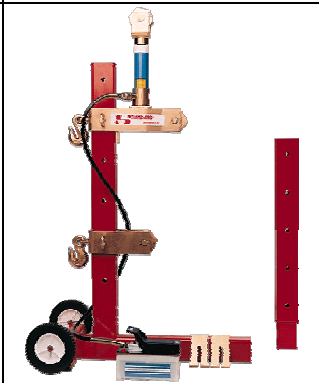

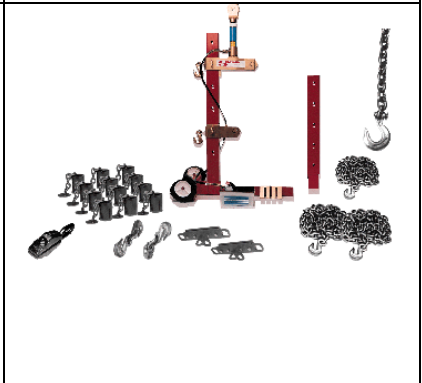





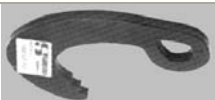

Section 4: Accessories

Section 5: Standard Tools' warranty for this booth. It is a good idea to mark this page with the date these items are received and the order number for future reference.

SECTION 1 - SYSTEMS AND ITEMS

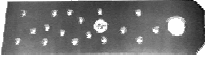
MODELS

4400	4401	4402	7662
POWER PULLER PACKAGE	POWER PULLER WITH HYDRAULICS	POWER PULLER FRAME	STARTER KIT
			

ITEM #	DESCRIPTION	PHOTO	4401	4400	7662
4404	5' TIE DOWN CHAIN			1	2
4405	9' LONG PULLING CHAIN				1
4406	DOUBLE CHAIN HOOK			1	2
4407	DOUBLE BLOCK PULLER			1	
4409	LARGE HOOK			1	
4410-S	QUARTER PULLER			1	
4411-S	MINI PULLER			1	
4412	SHEET METAL PULLER			1	
4413	UNITZE CLAMP				2
4428	BUMPER PULLER			1	
4434	ANCHOR POT				12
4557	10-TON HOSE	SIMILAR MAY BE SUBSTITUTED	1	1	1
4562	10-TON PUMP	SIMILAR MAY BE SUBSTITUTED	1	1	1
4609-6	10-TON RAM	SIMILAR MAY BE SUBSTITUTED	1	1	1
4882	HOSE END	SIMILAR MAY BE SUBSTITUTED	1	1	1
6373-10	10'X3/8 CHAIN WITH SLIP HOOK			1	1
6562	FRAME RACK ASSEMBLY			2	
6565	HOLE PULLING PLATE			1	
6582	2-1/2" SHEET METAL PULLING CLAMP			1	
6585	1-1/2" SHEET METAL PULLING CLAMP			1	1
6589	EASY HOOK			1	

ITEMS INCLUDED IN 4400

4401 DOES NOT INCLUDE CHAINS

4402 DOES NOT INCLUDE HYDRAULICS OR CHAINS

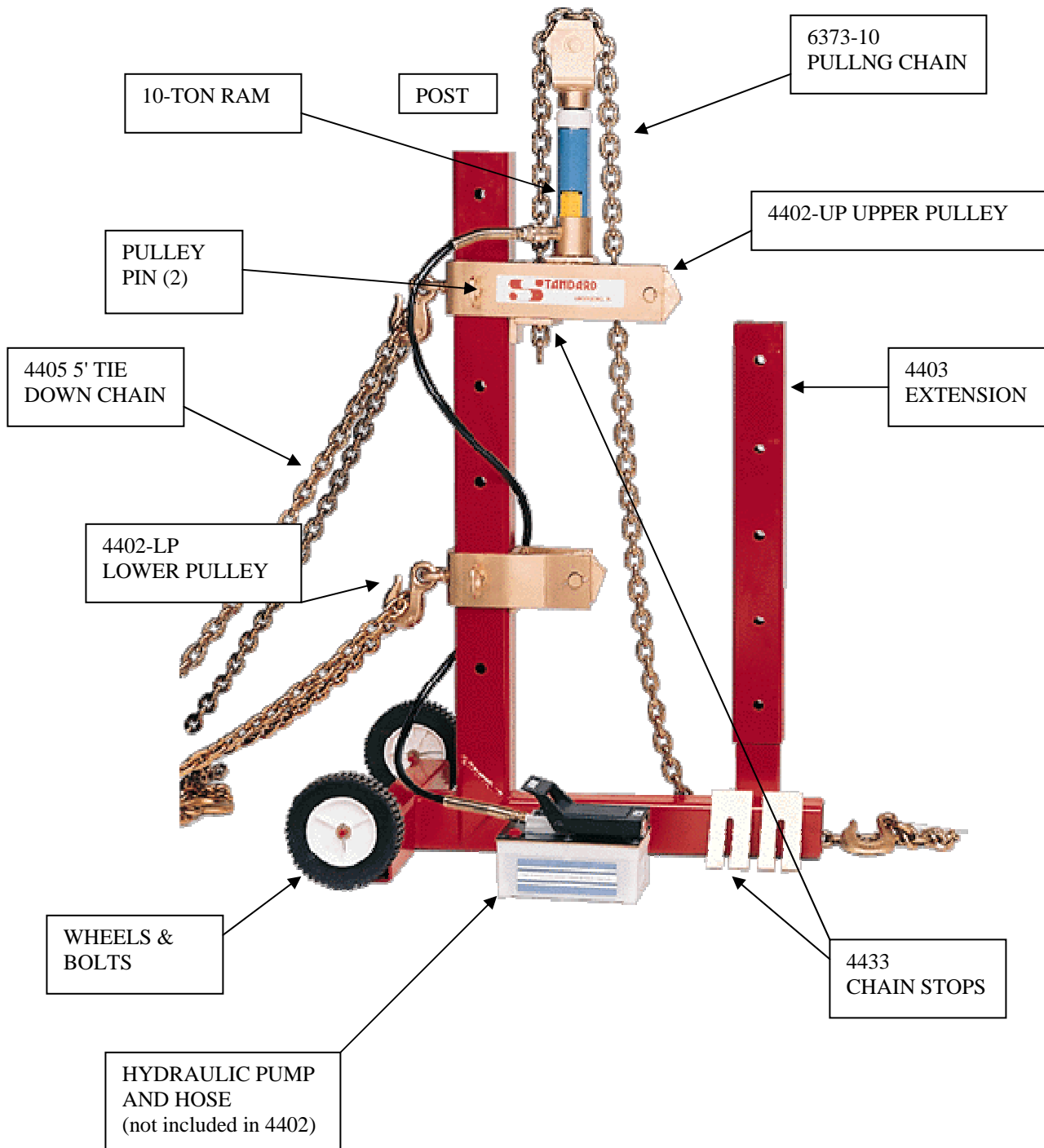

SECTION 2 - INSTRUCTIONS AND WARNINGS

I. INTRODUCTION

Congratulations on purchasing **Standard Tools' Power Puller**. This unit is made in the USA and designed to provide simple and safe pulling power without the use of a bed-style frame machine.

This unit is designed to be used with anchor pots. See our 4434 or our 4412 systems if you do not have these anchor pots. See Part IV of this section for installation instructions for the anchor pots.

It is assumed that the user is skilled in frame and collision repair. This manual does not instruct how to repair collision damage; it is a manual that shows how the equipment is set up to provide a pull.

This manual is not intended to replace or supersede any OSHA or other associated codes and regulations. It is highly recommended that the user of this equipment be fully skilled in collision repair to prevent serious harm to persons, automobiles or equipment.

II. PROCESS

1. Verify that the work area is clear of obstructions and will allow access to all anchor pots, the pulling post and the automobile.
2. Position the post with the long tube section (on the floor) facing the direction of pull.

3. Use the drawings here to determine the best manner of setting up the post, chains and pulleys.
Do not use the double pull with the height extension for heavy pulls.

Medium-Regular Pull

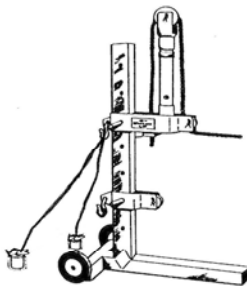

Low Pull

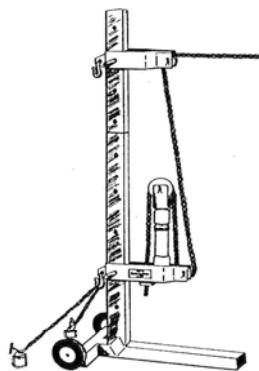
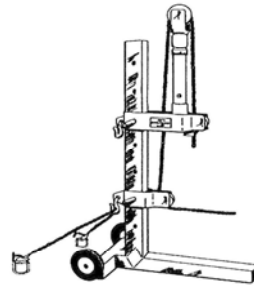

High Pull

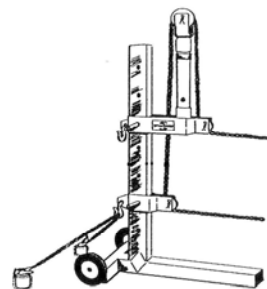

Double Pull

4. Use the chain-stop to secure the chain on the pulley bracket.
5. Connect the pulling chain to the vehicle based on the pulling requirement (This step must be done by a skilled user to prevent injury or damage).
6. Connect the pump and ram with the hose. Connect the airline to the pump.
7. Initiate pulling by actuating the pump with the foot plate.
8. Release the pull by pressing the front of the foot plate on the pump.

III. CONTINUOUS PULL

This task is done when the ram does not provide as much pull length as desired. Not intended for double pull.

PROCESS

1. Perform the pull in normal manner.
2. Position secondary chain so that chain-stop can be inserted against pulley bracket.

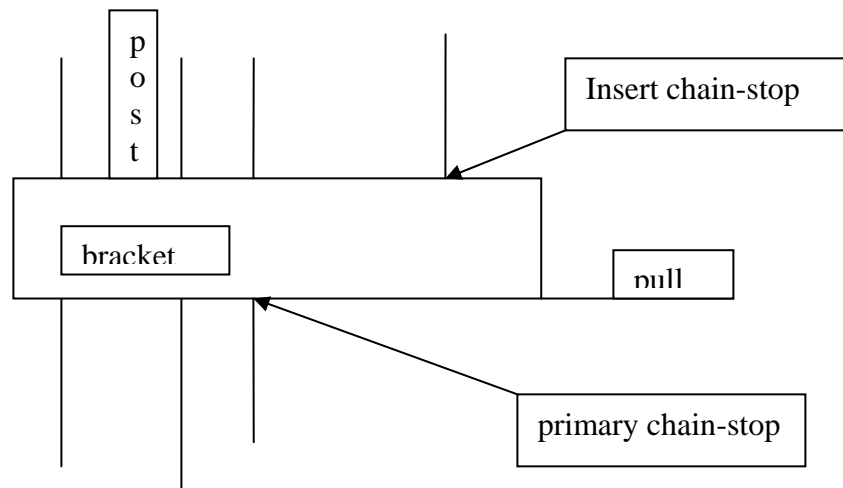

3. Insert continuous chain-stop.
4. Reduce pressure on ram force.
5. Move chain to re-set the primary chain-stop and ram to bottom on stroke.
6. Take up slack in chain by increasing ram pressure.
7. Remove secondary chain-stop.
8. Repeat as necessary.

IV. ANCHOR POT INSTRUCTIONS

- a) Flooring must be at least 4" thick of concrete in good condition (not oil-soaked or flaky).
- b) Refer to the diagrams below for recommended placement of pots.
- c) Drill 3-1/2" diameter hole at least 5-1/2" deep with a diamond-core bit and a water-cooled drill. This may pass through the flooring and into the soil. Anyone operating this drill or standing nearby should wear protective item such as thick clothing, eye protection and hearing protection.
- d) Place chain in the T-slot of the cast wedge between first and third link.
- e) Insert chain wedge in T-slot and gently tap in place to secure.
- f) Place the sleeve over the wedge and draw up by pulling chain.
- g) Tap the assembled unit into the floor until the top of the pot is even with the floor.
- h) Secure to pulling post chain with chain hook for use. The wedge will pull up into the sleeve while the sleeve spreads and fills the hole, creating a locking action.
- i) When not in use, keep the short chain in the pot and the pot covered with the anchor pot lid to prevent damage or trash accumulation.

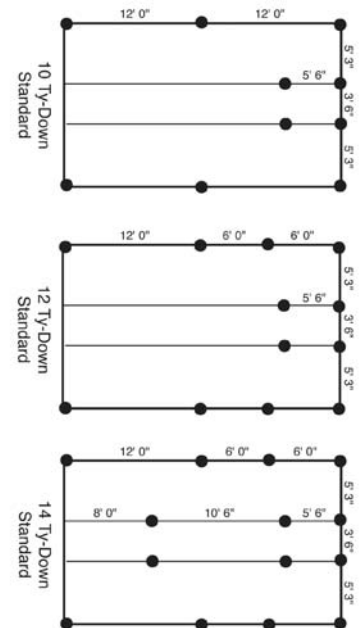
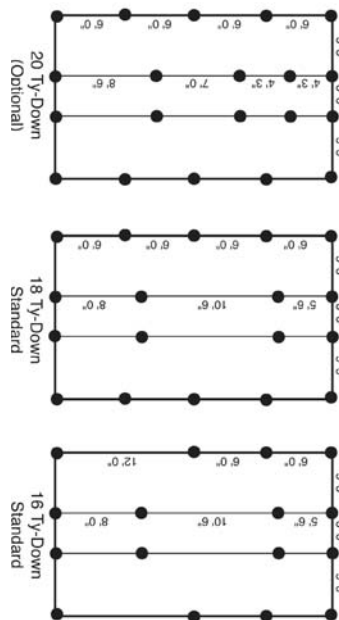
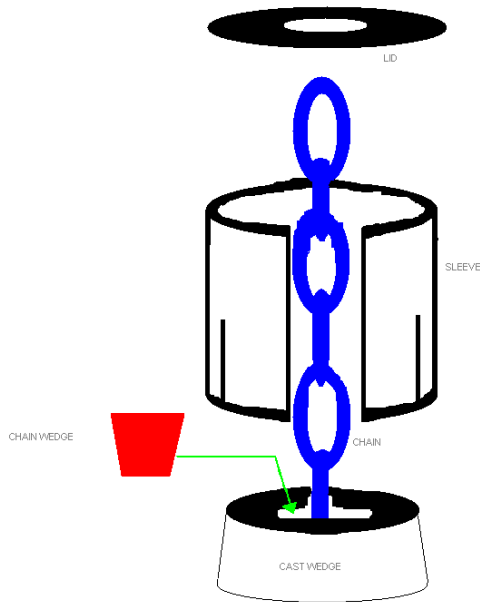

V. NOTES/WARNINGS

1. Chains must be used with no twists. Twisted chains are prone to breaking at less than their rated strength.
2. All chains, hooks, hydraulics and the posts should be inspected prior to each use to identify and correct any damage or other issue.
3. These power pulling systems are under significant force during use. Incorrect usage may lead to vehicle parts becoming unattached or the pulling equipment moving during a pull. It is critical that the operator be knowledgeable about the pulling process and pulling techniques beyond this manual.
4. The pulling post must squarely face the pull with the chain at a right angle to the post (viewed from above). The post will automatically move to this alignment when pulling begins if the setup is not at a right angle.
5. All local codes and OSHA codes that apply to the use of this product should be noted and used for training and operational use.

SECTION 3 -MAINTENANCE

The following tasks should be performed before each day's use of this equipment:

- check hoses and chains for damage or unusual wear that would required repair or replacement
- check hose connections
- check hydraulic fluid level (Do not overfill. Fill only when ram is not extended.)
- visually inspect chains and hooks

The following tasks should be performed monthly:

- visually inspect all welds to verify that pulls have not caused damage
- visually inspect hooks pins
- check wheel bolts, tighten as necessary
- verify angle of post to floor plate to verify that pulls have not damaged the post

The following tasks should be performed every six months:

- replace hydraulic fluid in ram and pump
- cover an exposed metal with spray paint to prevent rust that could cause weakening of the post

SECTION 4 - ACCESSORIES

1. 4419 - Snap-block Pulley

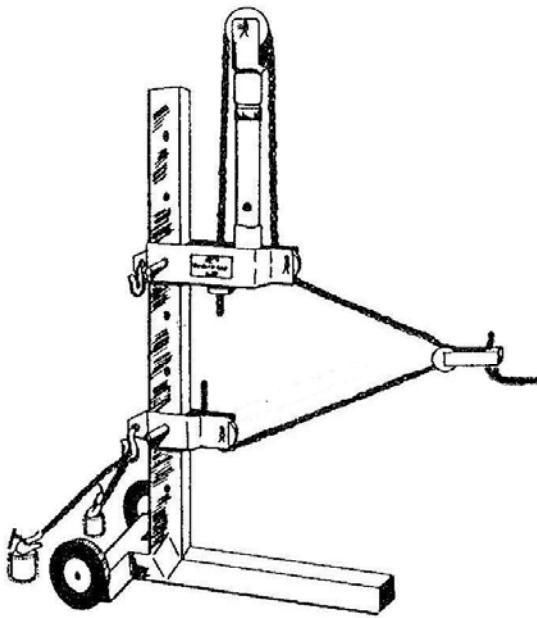

20-ton pull with 4419

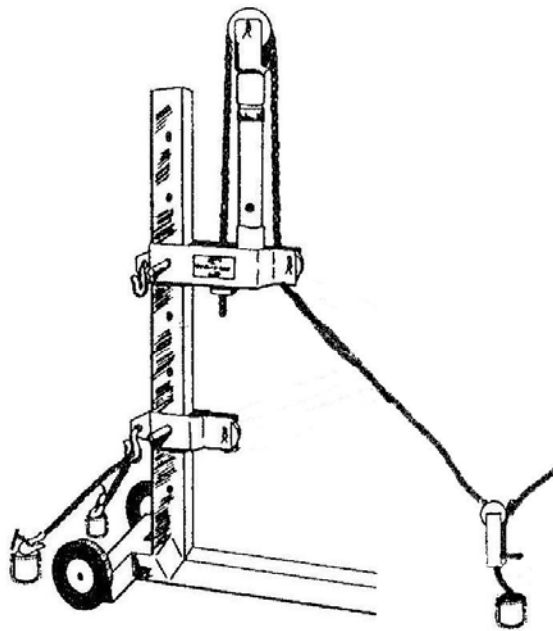

Down-pull with 4419 & anchor pot

Allows 20-ton pull (requires second chain, not included)
Allows down-pull to anchor pot.

Do not use for continuous pull.

2. Height Extension

4403 included in all 4400-series systems

Adds 36" of height for higher pulling points.

5-ton max pull.

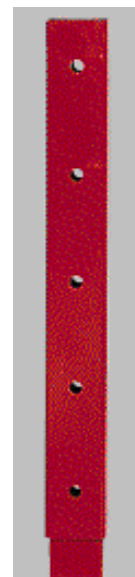

SECTION 5 -WARRANTY

Standard Tools will, within 5 years of purchase date, replace F.O.B. the factory, any materials which are defective in materials and/or workmanship. This warranty is subject to the inspection of the seller and seller's judgment to determine if the items have been modified or subjected to abnormal use, abuse or a lack of proper maintenance. This warranty does not extend to labor costs or loss of use due to defect. It also does not extend to any collateral or consequential damage due to defect.

At the seller's option, the buyer must return the defective items (freight and delivery paid by seller, packaging by item owner) to Standard Tools. The hydraulic ram, hose and pump are subject to the manufacturer's warranties only.

Seller will not be liable to the buyer for any personal injury or property damage arising from the use of this equipment or installation of equipment.

This warranty is limited to the original equipment buyer and is not transferable.

No officer, employee or agent of seller is authorized to make any oral representations or warranty of fitness or to waive any of the foregoing terms of sale and shall be binding beyond this written warranty.

Standard Tools recommends that the buyer complete the following upon reading of this manual to allow easy access to this information if a call is required to our Customer Service department for any warranty or other relevant concerns.

Purchaser: _____

Address: _____

City, St: _____ Zip: _____

Purchaser's Signature : _____

Date of Purchase: _____

Model Purchased: _____

Order Number: _____